



**MADE TO MEASURE HAND CRAFTED
GARAGE DOORS BRITISH MADE**

2023

selectgaragedoors.co.uk



Who we are

Established in 2000 in Bolton and now based in Walkden, Select Garage Doors is a family run business that has been manufacturing made to measure garage doors for garage door specialists for over 22 years.

We are now one of the UK's leading manufacturers of steel side hinged garage doors. We have distributors in the UK covering areas in the North West, Yorkshire, the Midlands and parts of the South.

Our product list also includes Up & Over garage doors, Personnel doors and door accessories. We offer 12 different designs made from steel which we produce in a range of RAL colours. Some of our door designs can also be made with windows in the top panel and we have a variety of window options to enhance the look of your garage door.

We don't mass produce standard size products. We produce high quality, made-to-order garage doors that cater to specific garage door needs. All of our doors are manufactured on site from fabrication through to powder coating in our state-of-the-art factory.

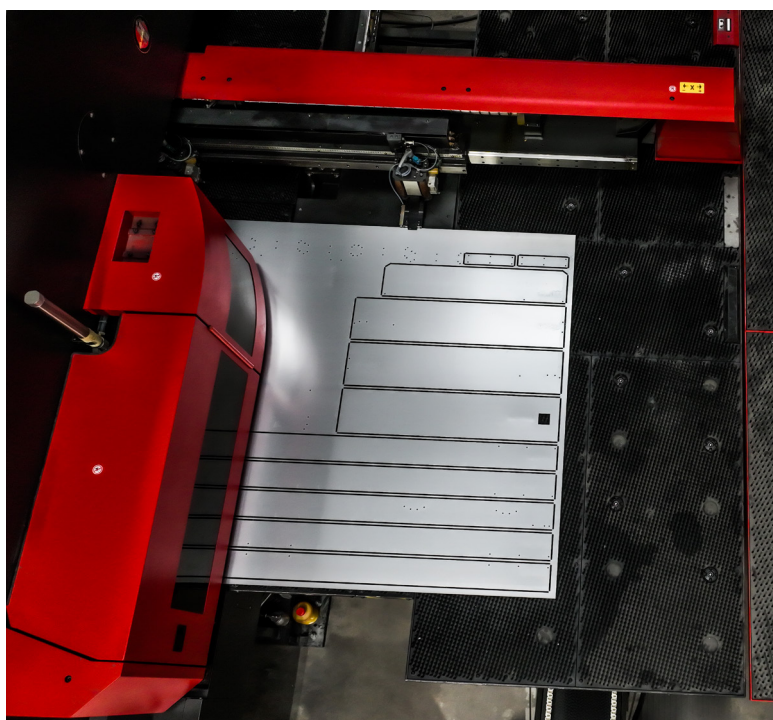

Product Types

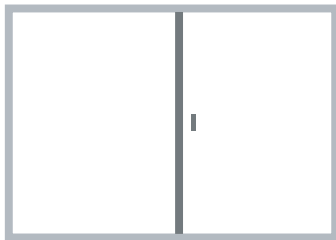

Centre Split



Off-Centre Split



Canopy

Side Hinged doors are available as **Centre Split** or **Off-Centre Split** depending on size and design. The right or the left can be the leading door and doors can open in or out. On off centre split doors the large or the small door can be the leading door. As standard doors will be supplied with a brushed steel effect night latch lock and matching brushed steel hinges. Unless specified at the time of order, doors will be made with the first door opening door on the right as viewed from outside, opening out.

Canopy doors use an overhead torsion spring and vertical tracks fixed directly to the frame. The lack of ceiling suspended tracks allow for full drive-thru clearance. Multi point locking with euro profile lock centred in the top third of the door.

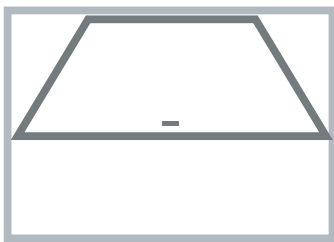

Retractable



Bi-Fold



Personnel

Retractable doors offer smooth operation and balance, ideal for electric automation. Secured with a 2-point slam latch with euro lock handle. Overhead tracks are required for this frame type. Wicket doors are an optional extra in the Rivington design.

Bi-folds are available on most side hinged door designs and can open either in or out. They are available in our powder coat finishes. Where a door has a centre split only the second opening door can bi-fold.

Personnel doors can be hinged on either side and can open in or out. Unless specified at the time of order doors will be made with the hinges on the left as viewed from outside opening out with brushed steel night latch and matching hinges.

For more details on all our products please see our website
www.selectgaragedoors.co.uk



Rivington range

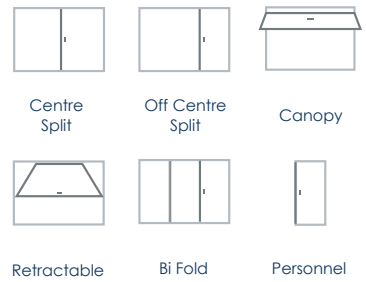

Adlington range

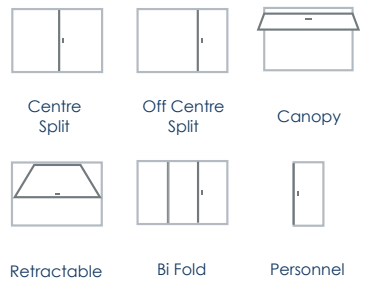



Cartmel range



Centre Split



Off Centre Split



Canopy



Retractable



Bi Fold



Personnel



Rivington Wicket range



Retractable



Belmont range



Centre Split



Off Centre Split

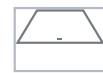

Retractable



Personnel

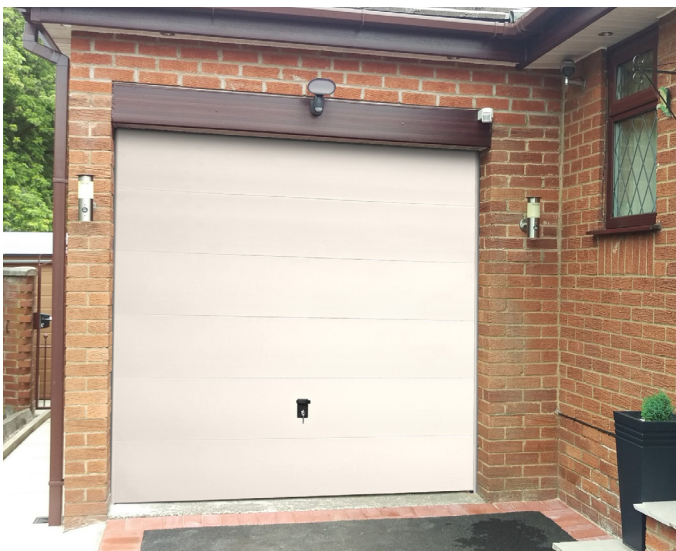

Rufford range

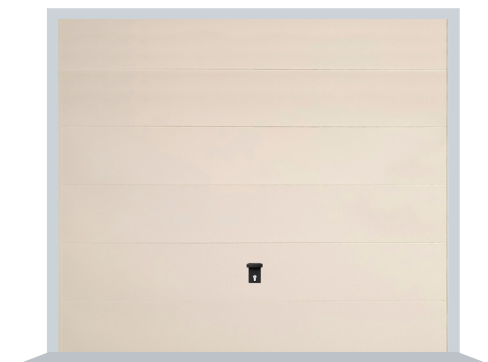

Retractable



Personnel

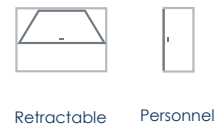

Croston range

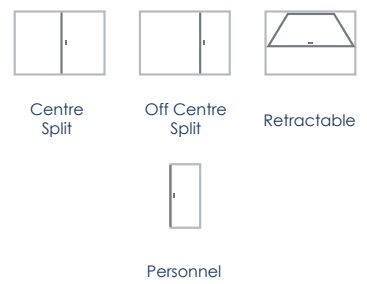

Gisburn range



Bowdon range

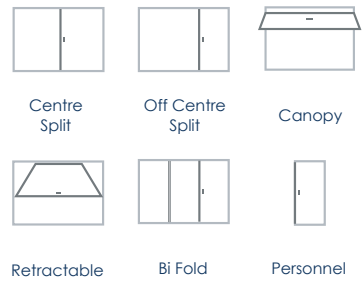

Derwent range

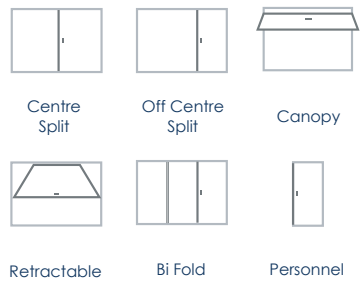



Langdale range

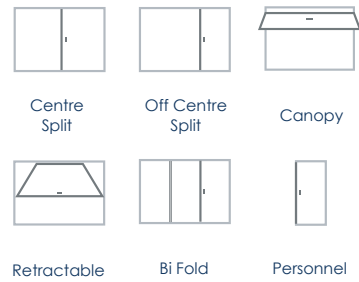

Personnel

Our **Personnel** doors can be used for a range of applications, whether you want a matching side door for your garage, or need some added security for a shed or annex.

All door designs are available in Personnel versions.



Lifebeck Range

Lifebecks are variants of the Bowdon, Cartmel and Rivington ranges that include windows in the door.

Decraglass, Decralead Glass and **Plain Obscured Glass** are all available with a wide range of style options, see page 11 for details.

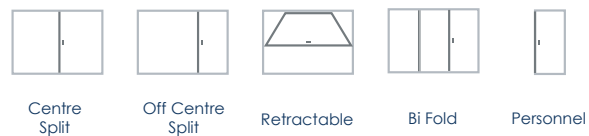

Window Frame System

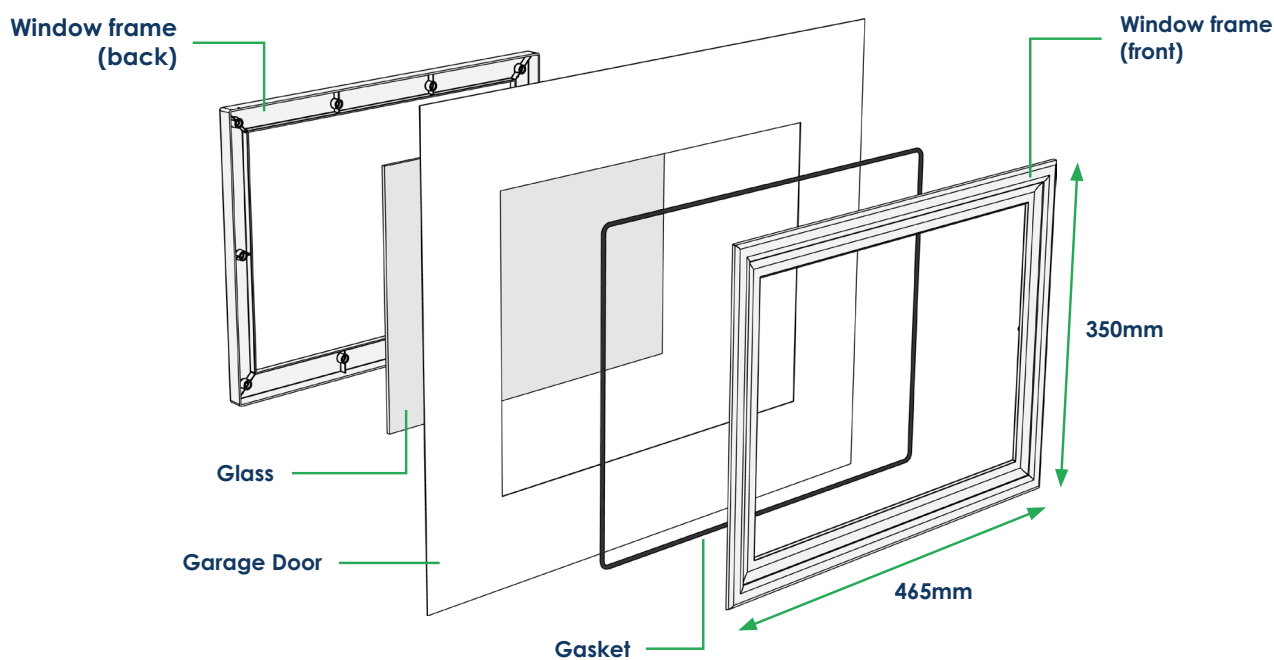

Windows for Litebeck Doors

Decralead

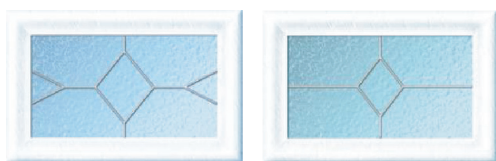

Swiss

Crystal

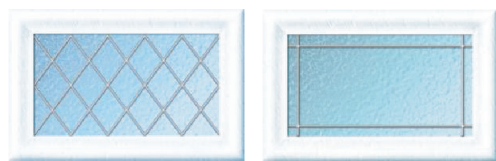

Diamond

Austrian



Georgian

Vista

Decraglass



Rose

Bluebell

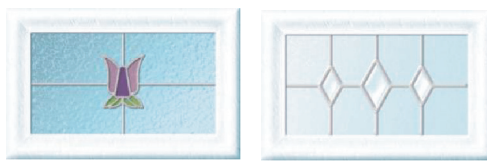

Tulip

Pearl Drop



Tiara

Plain Obscured



Plain

WINDOWS ARE ONLY AVAILABLE FOR THE RIVINGTON, CARTMEL AND BOWDON RANGES
 BESPOKE DESIGNS AVAILABLE ON REQUEST
 WINDOW FRAMES NOT AVAILABLE IN WOOD GRAIN

Side Hinged Options

With our additional extras you can enhance the appearance of your garage door.



Standard options



Brushed Steel Hinge



Rollerbolt Brushed Steel

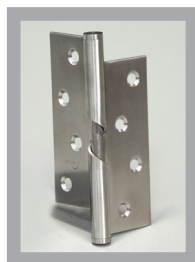

Rising Butt Hinge



Brass Hinge



Rollerbolt Brass

Additional Extras

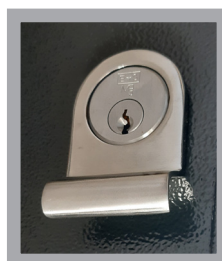

Finger Pull



Large Pull Tubular Stainless Handle

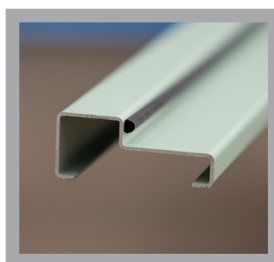

Aluminium Threshold
(supplied same colour as frame, unless specified)

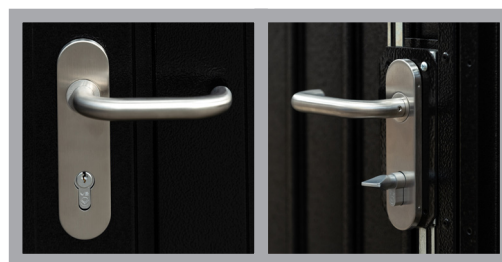

Lever Handle Lock

Side Hinged Options



Lever Handle Lock
Locks securely at both the top and bottom of the door.

Lever Handle Lock Top
The upper bolt locks behind the door frame.



Top Shoot Bolt Lock

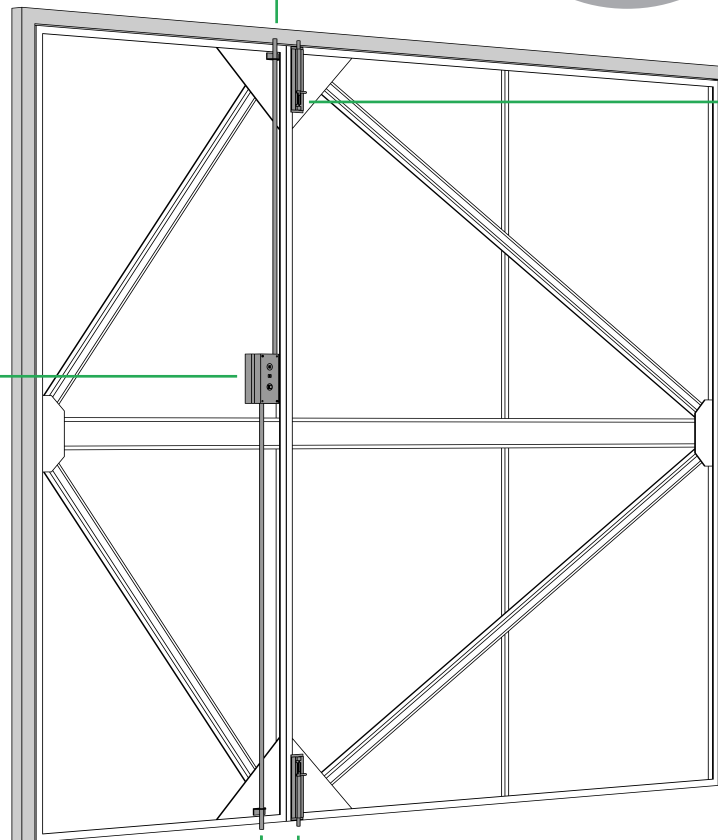

Lever Handle Lock Bottom
The lower bolt locks into a drilled ground recess.

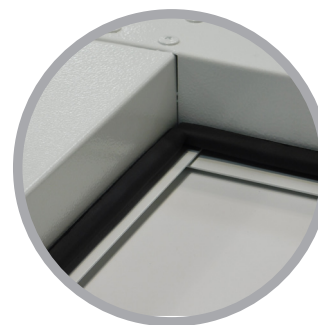

Door Frame
Powder coated frame, rubber seal.

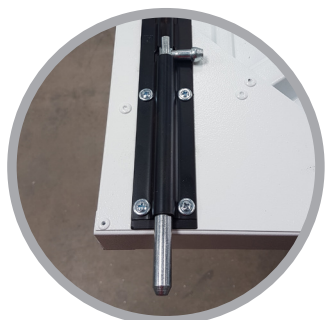

Bottom Shoot Bolt Lock
The bottom bolt locks into a drilled ground recess.

Up and Over Options

With our additional extras you can enhance the appearance of your garage door.



Up and Over Door Handle Options



Handle Black



Handle Brushed Steel

Colour Range

Price Range A	Price Range B		Woodgrain Laminates
7016 Anthracite Grey	1015 Light Ivory	7011 Iron Grey	Golden Oak Laminate
9005 Jet Black	3003 Ruby Red	7032 Pebble Grey	Rose Wood Laminate
9016 Signal White	3020 Traffic Red	7035 Light Grey	
	5005 Signal Blue	7038 Agate Grey	
	5011 Steel Blue	9001 Cream	
	5013 Cobalt Blue	BS-00-A-05 Goose Grey	
	6005 Moss Green	BS-08-B-29 Vandyke Brown	
	6009 Fir Green	BS-14-C-35 Chartwell Green	

SAMPLES ARE AVAILABLE ON REQUEST.

All fully finished doors are supplied in ripple finish.

We can supply different RAL colours POA.

Woodgrain Laminates are not available for the Litebecks or any Georgian square design doors.

Dark colours are not recommended for sunny spots

COLOURS MAY HAVE VARIATIONS BETWEEN DIFFERENT BATCHES

Select Steel Warranty

Select Garage Doors Ltd provides a five year limited warranty against manufacturing defects from date of purchase. In the event of a claim, please contact the distributor who originally supplied the product, who will then supply details of the claim along with proof of purchase to Select Garage Doors Ltd. Valid claims will be repaired or replaced at our discretion.

Operating gear

All product must be installed in accordance with installation instructions. Moving parts should be lubricated 3 to 4 times a year to ensure smooth operation. A qualified engineer must inspect and carry out repairs/replacements as necessary. **DO NOT ATTEMPT THIS YOURSELF, AS THIS COULD BE POTENTIALLY DANGEROUS.**

Appearance

During the manufacturing process it is possible that some distortion in the panels may occur. A visual inspection should be carried out in natural daylight (not direct sunlight) from a distance of 3 metres to view the overall appearance, minor marks and blemishes not seen from this distance will not be covered by warranty.

Finish Warranty

Primed steel doors must receive a suitable exterior topcoat immediately after installation. This coating is not covered by warranty.

Factory finished powder coating is covered for 5 years. Laminate wood grain finish is covered for 5 years. Surfaces must be freely exposed to washing by rainfall and kept clear of birds droppings, accumulated dirt and debris. The door and frame should be kept free from impact damage, scratches and other surface abrasion. Damage, corrosion or discolouration caused by contact with an excessively salty atmosphere, abnormal elements within the building or from pollution, chemicals, or caustic substances are excluded from warranty.

Cleaning

Cleaning should be carried out with a soft, non abrasive sponge and clean water.

The company reserves the right to make alterations in design and manufacture as are deemed necessary without notification.

Note:

Our products are not suitable for use as gates on external installations.

